

FICHES TECHNIQUES AIDE AU CHIFFRAGE



Documents à imprimer ou à remplir électroniquement
sur notre site dans: [Téléchargement, rubrique aide au chiffrage.](#)



P3 ECHELLES A CRINOLINE

P4 GARDE-CORPS

P5 SAUT DE LOUP

P6 LIGNE DE VIE

P7 ESCALIERS

MATIERE

- Acier galvanisé
- Aluminium
- Inox
- Peinture RAL _____
- Peinture RAL _____
- 304
- 316

Tampon société

Nom: _____
 Mail: _____
 Tel: _____

TYPE DE SORTIE

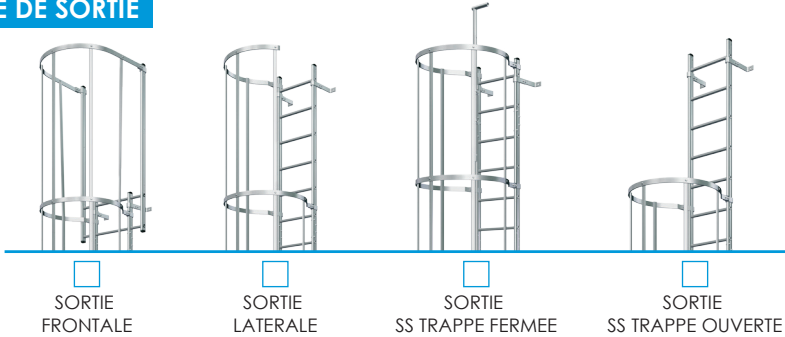

Si l'échelle comprend une ou plusieurs sortie(s) latérale(s) intermédiaire(s), préciser à quel(s) niveau(x) _____ mm



- Palier 1000 x 1000 mm avec garde-corps, portillon et 2 jambes de force

SUPPORT

- Béton
- Bardage _____
- Autre _____

PATTES DE FIXATION

- Standards
 Alu 200 mm
 Acier 250 mm
- Réglables
 Alu 150/300 mm
 Acier 200/300 mm
- Déportées
 Plusieurs tailles:
 Entre 345 et 1920 mm

PORTILLON, MARCHE PALIERE, PALIER



UNIQUEMENT SORTIE FRONTALE

Pour être conforme à la norme, l'échelle doit être équipée d'un portillon, d'une marche palière ou d'un palier de passage d'acrotère.

Hauteur à franchir: (A) _____ mm
 Largeur acrotère: (C) _____ mm
 Retombée: (B) _____ mm
 Quantité: _____

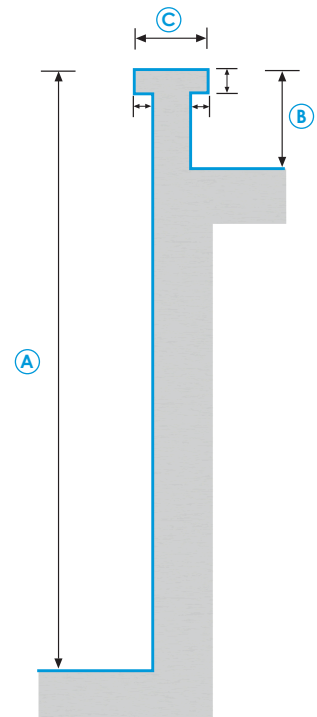

Modifier le croquis si autre configuration

CONDAMNATIONS

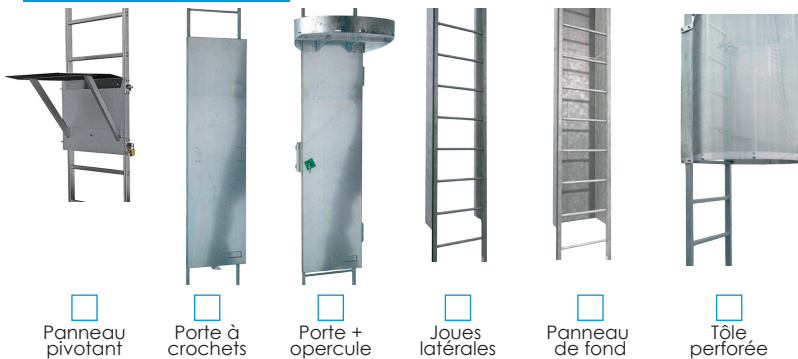

DIVERS



Coordonnées

Tampon société

Nom: _____

Mail: _____

Tel: _____

LINEAIRES

| | Linéaires par terrasse (ML) | Nombre d'angles entrants | Nombre d'angles sortants | Extrémités libres | Extrémités murales |
|---|-----------------------------|--------------------------|--------------------------|-------------------|--------------------|
| 1 | | | | | |
| 2 | | | | | |
| 3 | | | | | |
| 4 | | | | | |
| 5 | | | | | |

OPTION Thermolaquage RAL _____

TYPE GC



ACIER ALU



ACIER ALU



ACIER ALU

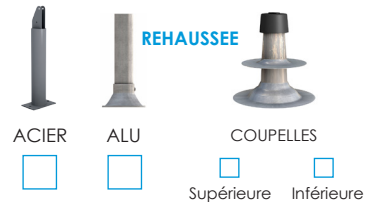

Supérieure Inférieure

Poteaux: Droit Incliné Rabattable

AUTOPORTANT



ACIER ALU

AUTOPORTANT BAC ACIER



ACIER ALU

BAC ACIER



ACIER ALU

Entraxe des ondes
 250mm 333mm

autre: _____ mm

Poteaux: Droit Incliné Rabattable

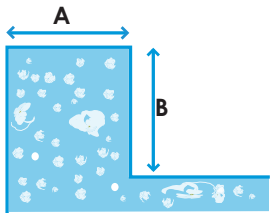

ACROTÈRE

A _____ mm

B _____ mm

Si acrotère isolée précisez épaisseur isolant: _____ mm

Observations/Schéma

Coordonnées

Tampon société

Nom: _____

Mail: _____

Tel: _____

CONFIGURATIONS

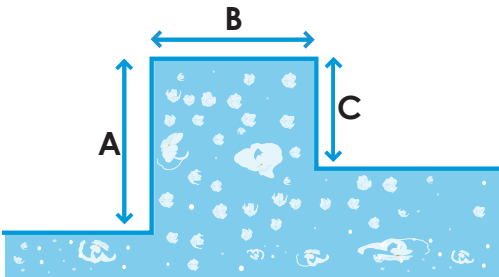

1

A _____ mm

B _____ mm

C _____ mm

Quantité: _____

2

A _____ mm

B _____ mm

C _____ mm

Quantité: _____

3

A _____ mm

B _____ mm

C _____ mm

Quantité: _____

ESCALIERS DOUBLE ACCES

Inclinaison 45°

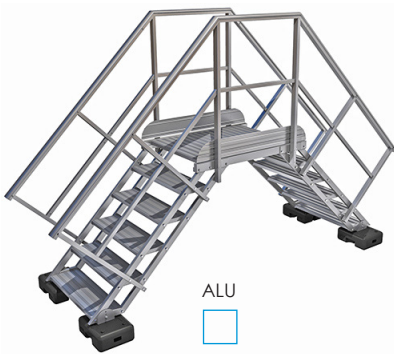

ALU



Raccord escalier/mur

Raccord palier/mur

Garde-corps 1 côté 2 côtés



ACIER



Raccord escalier/mur

Raccord palier/mur

Garde-corps 1 côté 2 côtés

ECHELLE A MARCHES

Inclinaison 60°



ALU

Garde-corps 1 côté 2 côtés

Remarques/croquis

Coordonnées

Tampon société

Nom: _____

Mail: _____

Tel: _____

TYPE DE LIGNE DE VIE

Avec chariot

Sans chariot

Avec rail

SUPPORT BETON

DALLE MUR

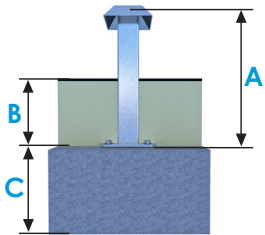

A _____ mm
 B _____ mm
 C _____ mm

SUPPORT COUVERTURE ZINC

VOLIGEAGE

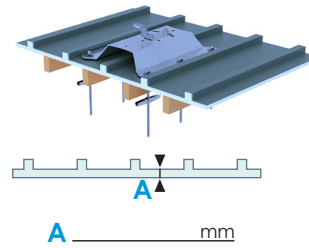

JOINT DEBOUT

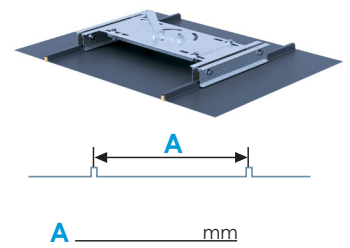

SUPPORT CHARPENTE

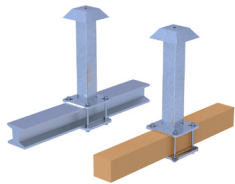

METAL

A _____ mm
 B _____ mm

BOIS

A _____ mm
 B _____ mm

SUPPORT BAC ACIER

BAC SEC

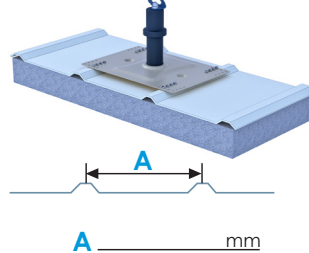

BAC ETANCHE

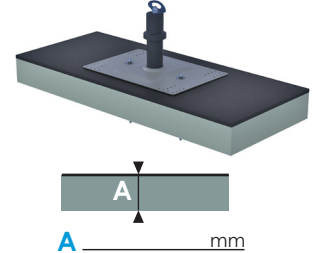

Remarques/croquis

Coordonnées

Tampon société

Nom: _____

Mail: _____

Tel: _____

UTILISATIONS

- Bureaux ERP Habitation Privé

FINITION

- Brut Galva Antirouille Thermolaquage(RAL): _____

DIMENSIONS

hauteur totale: _____ mm

HAUTEUR DES VOLÉES:

Hauteur 1: _____ mm

Hauteur 3: _____ mm

Hauteur 2: _____ mm

Hauteur 4: _____ mm

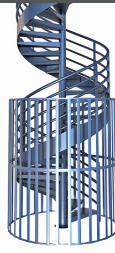

Barreaudage



Tôle perfo

OPTION CAGE

HAUTEUR CAGE

- Hauteur totale
 Autre: _____ mm

PORTE

- Verrou simple
 Barre antipanique
 Ferme-porte

TYPES DE MARCHES



Tôle lamée

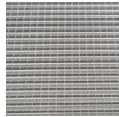

Caillebotis

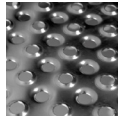

Tôle perfo emboutie



Bois

TYPES DE GARDE-CORPS



MC + lisse(s)

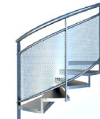

MC + tôle perfo



GC barreaudés

LIMON

LIMON CENTRAL

LIMON LATERAL

PALIERS

PALIER ARRIVEE

PALIERS INTERMEDIAIRES

Nb: _____

PIECES JOINTES

- CCTP
 Descriptif
 Plans/coupes
 Photos
 Croquis avec côtes

Remarques/croquis

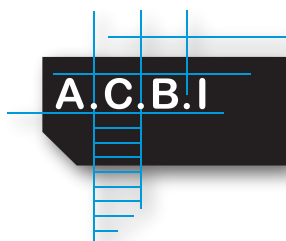

20 RUE DU BICENTENAIRE DE LA REVOLUTION

91220 LE PLESSIS PATE

TEL : 01 69 88 18 40

FAX : 01 84 18 03 14

www.acbi-sa.com

contact@acbi-sa.com



GARDE CORPS

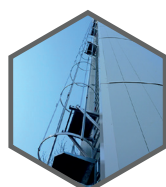

EHELLES



ESCALIERS



SAUTS DE LOUP



GARDE CORPS
PUBLIC



LIGNE DE VIE